



MODULAR

**LA NOSTRA STORIA,
LA RICERCA DEL COMFORT
DAL 1965.**

*OUR STORY,
THE PURSUIT OF COMFORT
SINCE 1965.*



Calia Italia, fondata a **Matera** nel **1965**, è l'azienda più antica del Distretto del Mobile Imbottito della Basilicata. Progetta, realizza ed esporta in tutto il mondo divani e poltrone in pelle e tessuto rinomati per l'**artigianalità**, la **cura dei dettagli**, l'attenzione per il **design** e l'inconfondibile **comfort**.

Puntando sulla valorizzazione del proprio territorio, investendo in ricerca e tecnologia, sviluppando la capacità logistica, l'azienda negli anni non ha mai smesso di crescere, diventando con la direzione artistica e creativa di **Saverio Calia**, e la strategia commerciale di **Giuseppe Calia**, una delle realtà più importanti e riconosciute al mondo nella realizzazione di "mobili imbottiti".

Grazie al lavoro di oltre **1500 persone** del territorio murgiano, Calia Italia realizza quotidianamente più di **1000 sedute**, con oltre **40 nuovi modelli** ogni anno, in **40 diversi rivestimenti** di pelli e tessuti, con più di **400 varianti** di colore per incontrare e soddisfare tutte le esigenze. Da un **magazzino interamente automatizzato** tra i più grandi d'Europa, il comfort pensato e realizzato a Matera raggiunge tutte le latitudini del mondo (dall'Europa all'America, dal Medio all'Estremo Oriente) per essere scelto ogni giorno in più di **90 paesi** da oltre **1000 persone**.

*Calia Italia, established in **Matera** in **1965**, is the most ancient company of the Upholstery Furniture District in Basilicata. The company designs, manufactures and exports worldwide sofas and chairs in leather and fabric, known for their outstanding **craftsmanship**, **care for details**, attention to **design** and unmistakable **comfort**. With the constant aim of promoting the territory, investing in research and technology and developing its logistics capacity, the company has never stopped growing over the years, thus becoming - under **Saverio Calia**'s artistic and creative direction and **Giuseppe Calia**'s commercial strategy - one of the most renowned companies in the production of upholstered furniture worldwide.*

*Thanks to the efforts of over **1,500 people** working in the Murgia area, Calia Italia guarantees a daily production of over **1,000 seats** a day, developing more than **40 new models** per year, in **40 different covers** both in leather and fabric available in over **400 colors**, in order to meet and fulfill all customers' needs. Calia Italia's comfort, conceived and made in Matera, is stored in one of the largest **automated warehouses** in Europe to be delivered to any place in the world (from Europe to America, from Middle to Far East) and is chosen every day in more than **90 countries** by over **1,000 people**.*



Matera, Sasso Barisano

YOUR COMFORT EXPERIENCE

Con la Modular Collection Calia Italia inaugura una nuova concezione dell'interior design: "lo spazio diventa tuo". Il divano è un oggetto dinamico, flessibile, creato per essere personalizzato da chi lo sceglie: sedute, chaise longue, pouf e versioni recliner rifiniti su tutti i lati possono essere composti e scomposti all'infinito, mentre la vasta gamma di colori e forme permette di dare al modello il proprio stile e carattere. Il prodotto viene ideato, progettato e realizzato in azienda, ma trova la sua massima espressione quando entra nell'ambiente casa e si immerge in una dimensione fatta di design e di vita, nella quale ognuno è progettista del proprio spazio e della propria comfort experience.

The 'Modular Collection' sees Calia Italia inaugurate a new concept of interior design: 'Lo spazio diventa tuo' (becoming your space).

A sofa is a dynamic, flexible object and it is created to be customised by those who choose it. Seats, chaises-longues, footstools and recliner versions (finished on all sides) can be composed and disassembled endlessly, while a wide range of colours and shapes can allow you to give a model its own style and character. The product is conceived, designed and manufactured by the company but it finds its maximum expression when it enters the home environment and is plunged into a dimension of design and life. It is a dimension in which everyone is the designer of their own space and comfort experience.

LAZY	07
MODULA	17
ELISEO	27
TANGO	37
HIP HOP	47
FOX TROT	57
JOHNNY	67



LAZY

EXPERIENCE



Design: Studio Pastina

Lazy è il divano dalle linee morbide e accoglienti che si ispira all'oggetto comodo per eccellenza: il cuscino. La semplicità delle forme nasconde un design ricercato e una grande attenzione ai dettagli: il modello prevede una versione recliner con comando touch per sollevare la pediera aumentando la profondità della seduta. Un ampio pouf angolare consente di azionare simultaneamente i meccanismi di entrambe le poltrone adiacenti e può trasformarsi in una comoda seduta grazie alla spalliera mobile zavorrata posizionabile a piacimento. Con tutte le sue possibilità, la comfort experience di Lazy è un vero e proprio viaggio che può portare ovunque. Nel 2020 Lazy ha vinto il German Design Award nella categoria Excellent Product Design.

Design: Studio Pastina

Lazy is a sofa with soft and welcoming lines and it is inspired by the comfortable object par excellence: the cushion. The simplicity of the shapes hides a refined design and a great attention to detail. The model includes a touch control recliner version that can lift the footboard and increase the depth of the seat and there is also a large corner footstool that allows for simultaneous operation of the mechanisms of both adjacent armchairs. Indeed, it can be transformed into a comfortable seat thanks to the ballasted mobile backrest that can be positioned as desired. With all its possibilities, the comfort experience of Lazy is a real journey that can take you anywhere. In 2020 Lazy wins the German Design Award in the category of Excellent Product Design.







LAZY_2 CAL1077_2

vers.540

POUF
1° RIV: RETE 3D 8349-7 BLU
OTTOMAN
RETE 3D 8349-7 BLU

vers.T63
CHAISE LONGUE SENZA BRACCIOLI
RANGER 79 BLU
ARMLESS CHAISE LONGUE
RANGER 79 BLU

vers.130
POLTRONA SENZA BRACCIOLI
1° RIV: RANGER 11 GRIGIO; 2° RIV: RETE 3D 8349-7 BLU
ARMLESS CHAIR
1st COV: RANGER 11 GRIGIO; 2nd COV: RETE 3D 8349-7 BLU

vers.E95
POLTRONA SENZA BRACCIOLI
RECLINER ELETTRICO
RANGER 11 GRIGIO
ELECTRIC RECLINER ARMLESS CHAIR
RANGER 11 GRIGIO

vers.557
POUF ANGOLO LUNGO DESTRO
RETE 3D 8349-7 BLU
RHF LONG CORNER OTTOMAN
RETE 3D 8349-7 BLU

vers.AH4
POLTRONA 1 BRACCIOLO DESTRO
FULL RECLINER ELETTRICO
1° RIV: RANGER 11 GRIGIO; 2° RIV: RANGER 79 BLU
3° RIV: RETE 3D 8349-7 BLU
ELECTRIC RECLINER FULL RHF CHAIR
1st COV: RANGER 11 GRIGIO; 2nd COV: RANGER 79 BLU
3rd COV: RETE 3D 8349-7 BLU

LAZY CAL1107

vers.AA8
POLTRONA TERMINALE SINISTRA BASCULANTE
PURE 4115 CUIOIO SCURO
TILT RHF TERM. CHAIR
PURE 4115 CUIOIO SCURO

vers.AA7
POLTRONA TERMINALE DESTRA BASCULANTE
PURE 4115 CUIOIO SCURO
TILT RHF TERM. CHAIR
PURE 4115 CUIOIO SCURO

LAZY_2 CAL1107_2
540+T63+130+E95+557+AH4



LAZY CAL1107
AA8+AA7

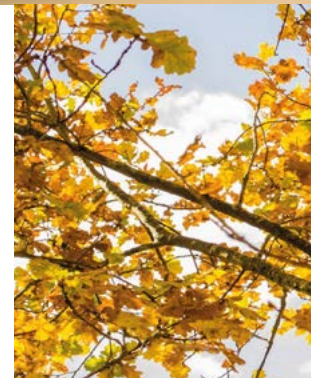

LAZY_2 CAL1107_2
540+T63+130+E95+557+AH4

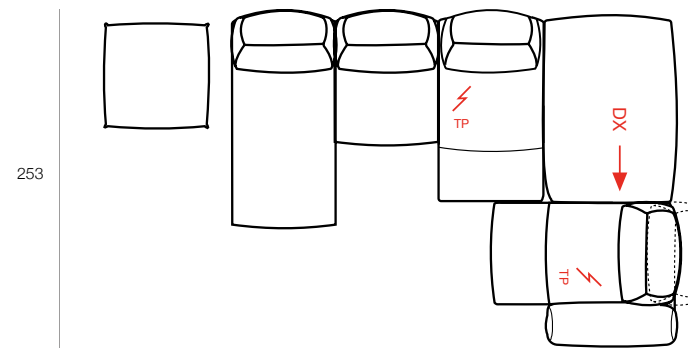

LAZY CAL1107
AA8+AA7

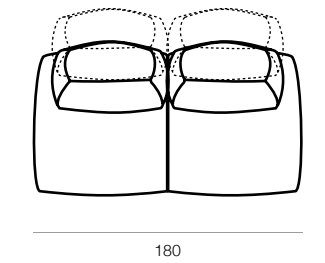

422/444



MODULA

EXPERIENCE



Design: Daniele Della Porta

Quando la comfort experience nasce dalla varietà e dalla libertà si chiama Modula. Composto da poltrone con forme morbide e schienali alti e accoglienti, Modula prevede elementi realizzati in tre larghezze differenti che permettono di creare infinite combinazioni e soluzioni angolari per ambienti di ogni dimensione. Il bracciolo, in versione large e X, è disponibile anche come contenitore e prevede una cover in legno per l'utilizzo del computer o come base stabile su cui poggiare altri oggetti. Può inoltre essere accessorizzato con luci, porta bibite, o caricatori per tablet e smartphone. Inserito nell'ADI DESIGN INDEX 2016, nello stesso anno Modula riceve il Premio Eccellenze del Design del Lazio.

Design: Daniele Della Porta

When the comfort experience comes from variety and freedom it is called Modula. Composed of armchairs with soft shapes and high, welcoming backrests, Modula includes elements made in three different widths that make it possible to create infinite combinations and corner solutions for environments of all sizes. The armrest, in large and X version, is also available as a container and provides a wooden cover for the use of a computer or as a stable base on which to place other objects. It can also be equipped with lights, drinks holders, or chargers for tablets and smartphones. Modula was awarded with the Premio Eccellenze del Design assigned in cooperation with the Lazio region.

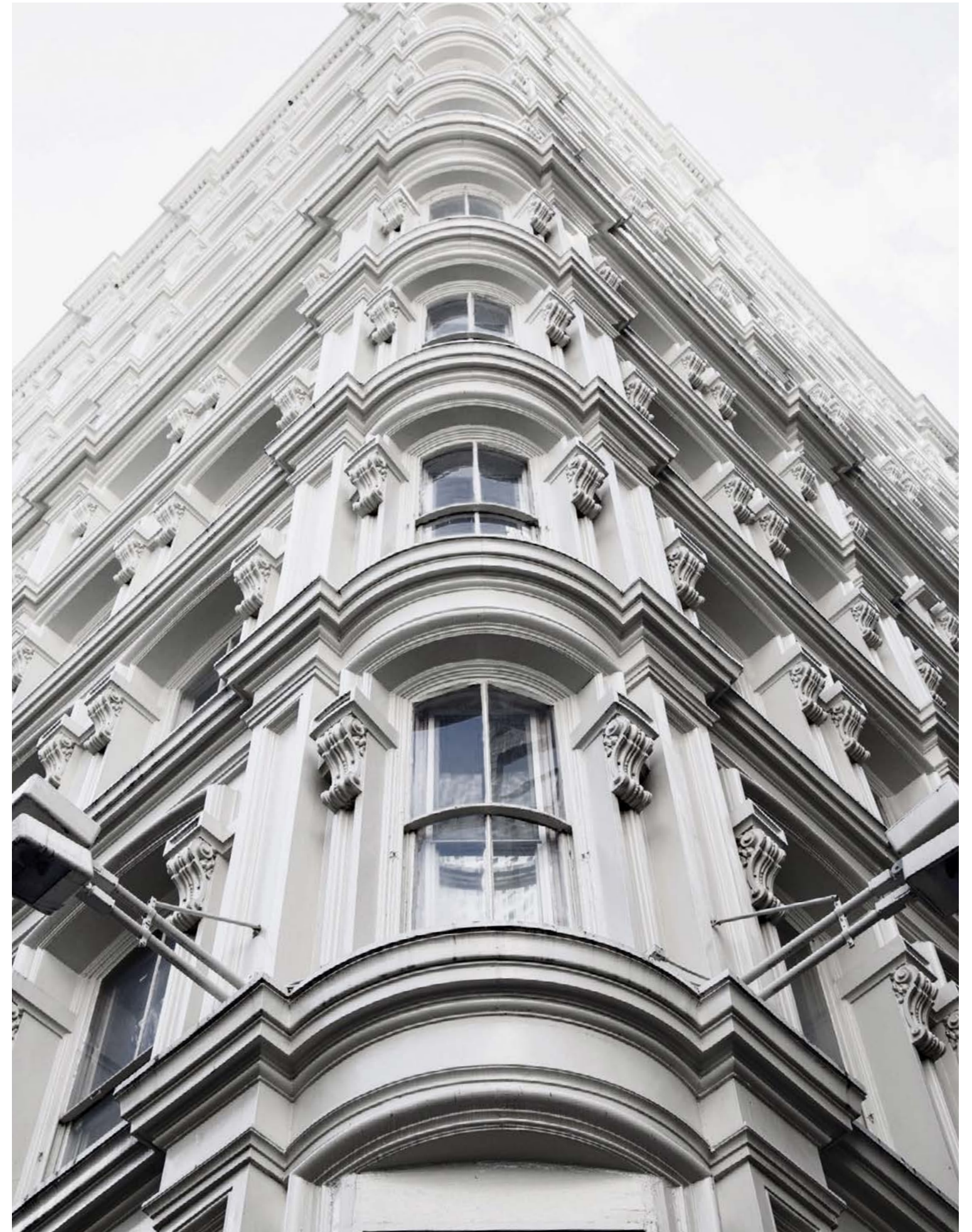

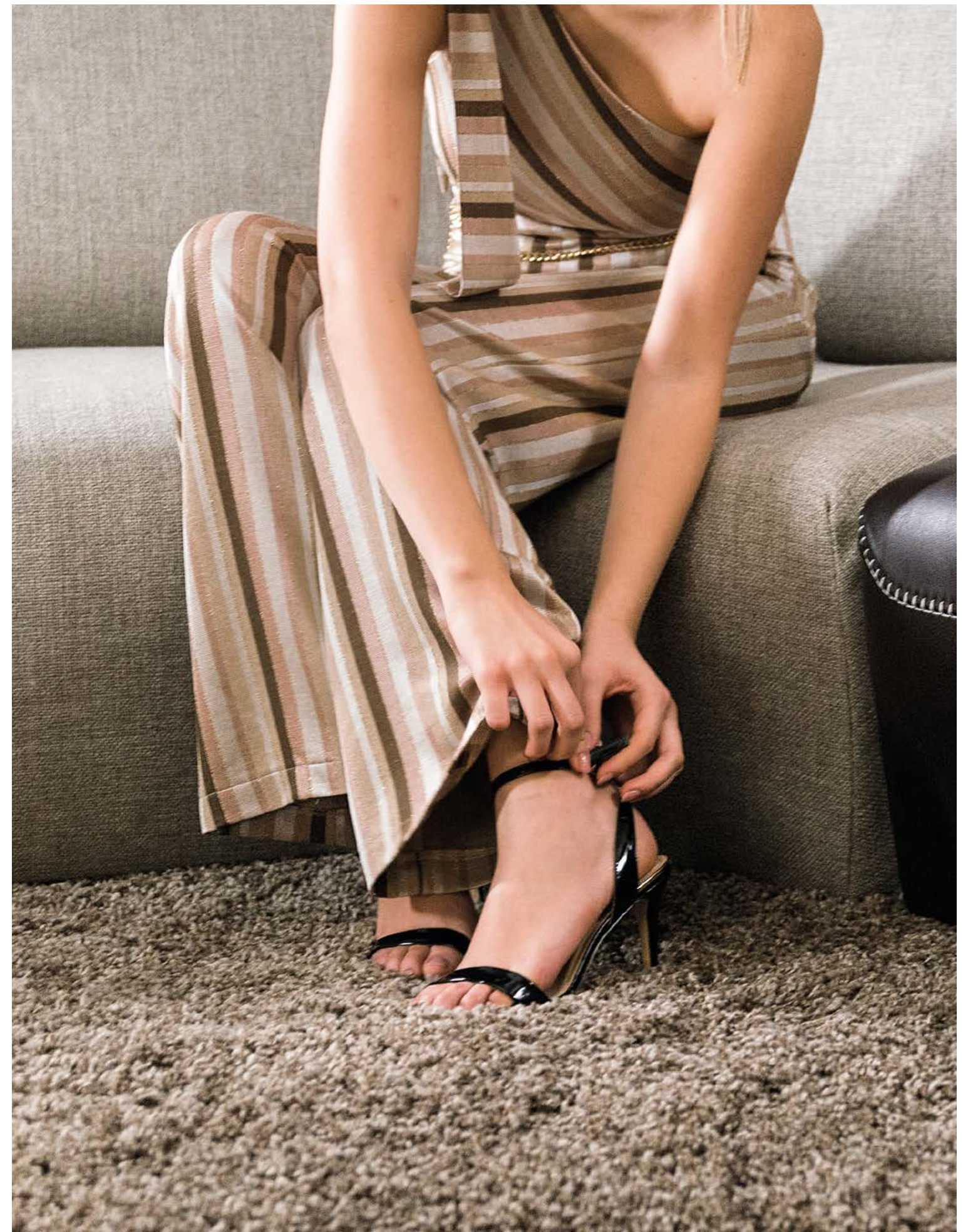



MODULA PRM1077_1019

vers.196
BRACCIOLO SMALL
MANHATTAN 600 GRIGIO
SMALL ARMREST
MANHATTAN 600 GRIGIO

vers.D62
POLTRONA SENZA BRACCIOLI MINI
SUAVE 1513 TESTA DI MORO
ARMLESS MINI CHAIR
SUAVE 1513 TESTA DI MORO

vers.191
ANGOLO SPECIAL SPALLIERA LUNGA SINISTRA
MANHATTAN 600 GRIGIO
LHF LONG BACK SPECIAL CORNER
MANHATTAN 600 GRIGIO

vers.144
POLTRONA SENZA BRACCIOLI MAXI
MANHATTAN 600 GRIGIO
144 MAXI ARMLESS CHAIR
MANHATTAN 600 GRIGIO

vers.198
BRACCIOLO LARGE
MANHATTAN 804 GIALLO
LARGE ARMREST
MANHATTAN 804 GIALLO

MODULA PRM1077_1019
I96+D62+I91+144+I98

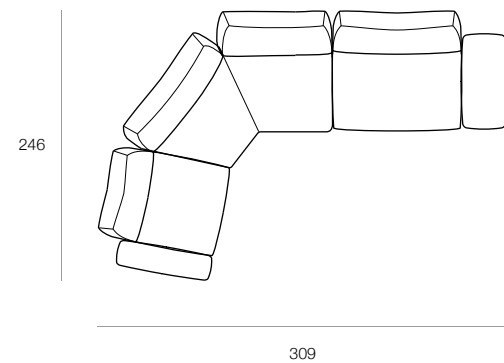

MODULA PRM1077_1019
I96+D62+I91+144+I96



ELISEO

EXPERIENCE

Un complemento di design studiato nei minimi dettagli per garantire una comfort experience senza eguali: Eliseo è il divano modulare di Calia Italia creato per avvolgere grazie ad uno schienale flessibile che si adatta al peso del corpo e alla seduta ampia caratterizzata dagli angoli smussati che nella parte terminale si sollevano diventando bracciolo. Uno stile che conquista tutti i sensi.

With a design conceived down to the smallest detail, Eliseo is a modular sofa by Calia Italia that guarantees an unparalleled comfort experience. Thanks to a flexible backrest that adapts to the weight of your body, along with a wide seat characterised by rounded corners that become armrests, Eliseo is designed to wrap around you in a style that will conquer all your senses.



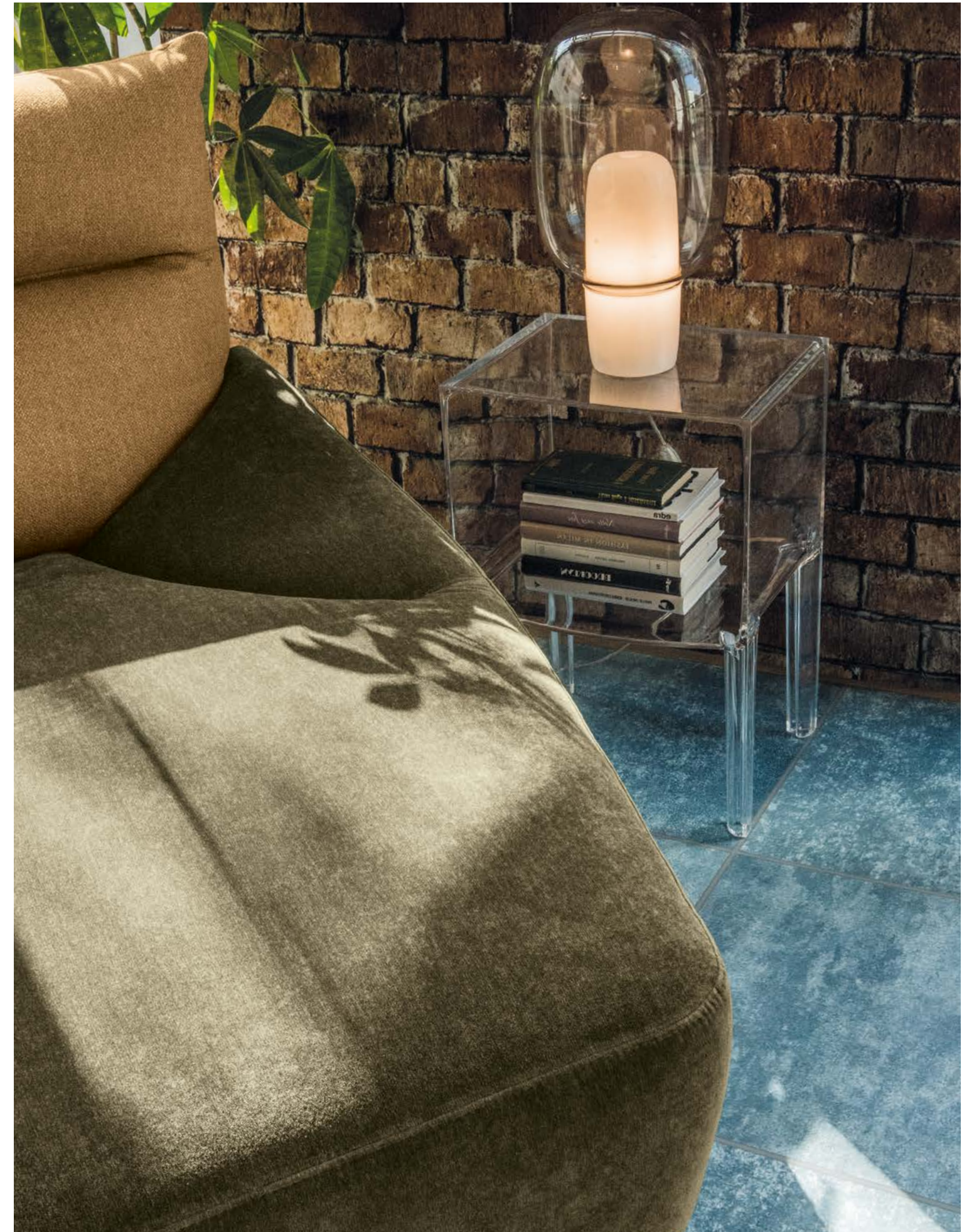



ELISEO PRM1127

ELISEO PRM1127
420+130+000+110

vers.420
CHAISE LONGUE 1 BRACCIOLO SINISTRO
1° RIV: YOU 062 VERDE
2° RIV: QUEBEC 35 SENAPE
LHF CHAISE LONGUE
1st COV: YOU 062 VERDE
2nd COV: QUEBEC 35 SENAPE

vers.130
POLTRONA SENZA BRACCIOLI
1° RIV: YOU 044 ARANCIO
2° RIV: QUEBEC 49 ROSSO
ARMLESS CHAIR
1st COV: YOU 044 ARANCIO
2nd COV: QUEBEC 49 ROSSO

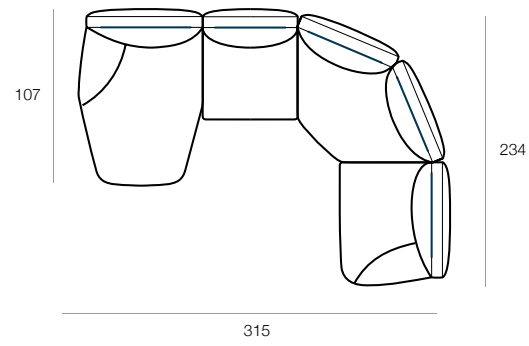

vers.000
ANGOLO
1° RIV: YOU 68 GIALLO
2° RIV: QUEBEC 44 BEIGE
CORNER
1st COV: YOU 68 GIALLO
2nd COV: QUEBEC 44 BEIGE

vers.110
POLTRONA 1 BRACCIOLO DESTRO
1° RIV: YOU 024 MUSCHIO
2° RIV: QUEBEC 28 ACQUAMARINA
1 RIGHT ARM FACING CHAIR
1st COV: YOU 024 MUSCHIO
2nd COV: QUEBEC 28 ACQUAMARINA

ELISEO PRM1127

vers.120
POLTRONA
1 BRACCIOLO SINISTRO
GLOBE 041 BLU
LHF CHAIR
GLOBE 041 BLU

vers.130
POLTRONA
SENZA BRACCIOLI
GLOBE 041 BLU
ARMLESS CHAIR
GLOBE 041 BLU

vers.071
ANGOLO TERMINALE DESTRO
GLOBE 041 BLU
RH-F END CORNER
GLOBE 041 BLU



ELISEO PRM1127
120+130+071

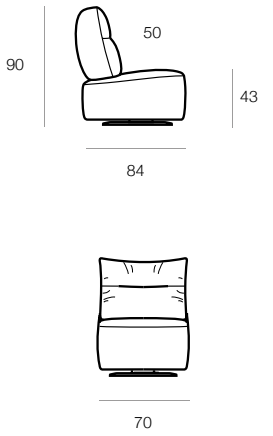

ELISEO PRM1127
120+130+071

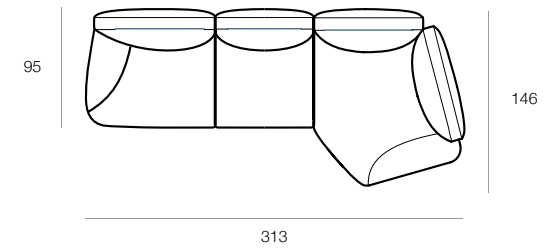

ELISEO PRM1127
420+130+000+110





TANGO

EXPERIENCE

Tango è il divano modulare che interpreta la dinamicità della vita contemporanea e la trasforma in un'esperienza di comfort. Un modello che unisce forme lineari e giochi cromatici per dare vita a composizioni fatte per accogliere e dialogare. Grazie a un meccanismo basculante, la spalliera del divano – arricchita da un soffice cuscino in piuma – cambia posizione aumentando la profondità della seduta. Tango è il divano in continuo movimento.

Tango is a modular sofa that interprets the dynamism of contemporary life and transforms it into an experience of comfort. It is a model that combines linear shapes and chromatic interplays that gives life to compositions that are made to welcome and create dialogue. Thanks to a tilting mechanism, the backrest of the sofa (enriched by a soft feather cushion) changes position thereby increasing the depth of the seat. Indeed, Tango is a sofa in continuous movement.









TANGO CAL827_818

TANGO CAL827_818
130+130+560+130+635

vers.130
POLTRONA SENZA BRACCIOLI
1° RIV: RUSH POIS 202 BEIGE
2° RIV: RUSH ASTRATTO 502 BEIGE
3° RIV: RUSH POIS 202 BEIGE
ARMLESS CHAIR
1st COV: RUSH POIS 202 BEIGE
2nd COV: RUSH ASTRATTO 502 BEIGE
3rd COV: RUSH POIS 202 BEIGE

vers.130
POLTRONA SENZA BRACCIOLI
RUSH ASTRATTO 502 BEIGE
ARMLESS CHAIR
RUSH ASTRATTO 502 BEIGE

vers.560
POUF BIG
RUSH ASTRATTO 502 BEIGE
BIG OTTOMAN
RUSH ASTRATTO 502 BEIGE

104/115

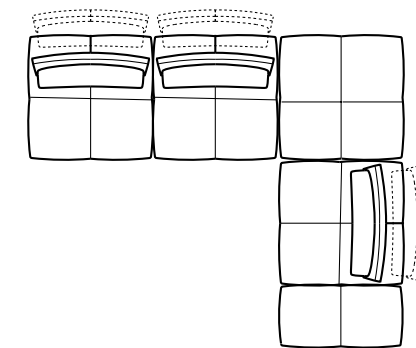

261/272

vers.130
POLTRONA SENZA BRACCIOLI
1° RIV: RUSH DISEGNO 102 BEIGE
2° RIV: RUSH ASTRATTO 502 BEIGE
3° RIV: RUSH DISEGNO 102 BEIGE
ARMLESS CHAIR
1st COV: RUSH DISEGNO 102 BEIGE
2nd COV: RUSH ASTRATTO 502 BEIGE
3rd COV: RUSH DISEGNO 102 BEIGE

vers.635
POUF RETTANGOLARE
PURE 4115 CUIOIO SCURO
RECTANGULAR OTTOMAN
PURE 4115 CUIOIO SCURO

312/323

TANGO CAL827_818

TANGO CAL827_818
T63+130

vers.763
CHAISE LONGUE SENZA BRACCIOLI
1° RIV: RUSH DISEGNO 102 BEIGE
2° RIV: RUSH ASTRATTO 502 BEIGE
3° RIV: RUSH ASTRATTO 502 BEIGE
ARMLESS CHAISE LONGUE
1st COV: RUSH DISEGNO 102 BEIGE
2nd COV: RUSH ASTRATTO 502 BEIGE
3rd COV: RUSH ASTRATTO 502 BEIGE

vers.130
POLTRONA SENZA BRACCIOLI
PURE 4115 CUIOIO SCURO
ARMLESS CHAIR
PURE 4115 CUIOIO SCURO



156/167

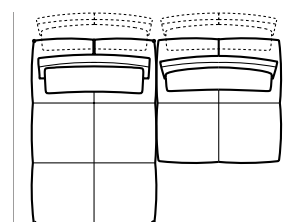

104/115

208

TANGO CAL827_818
T63+130



TANGO CAL827_818
130+130+560+130+635

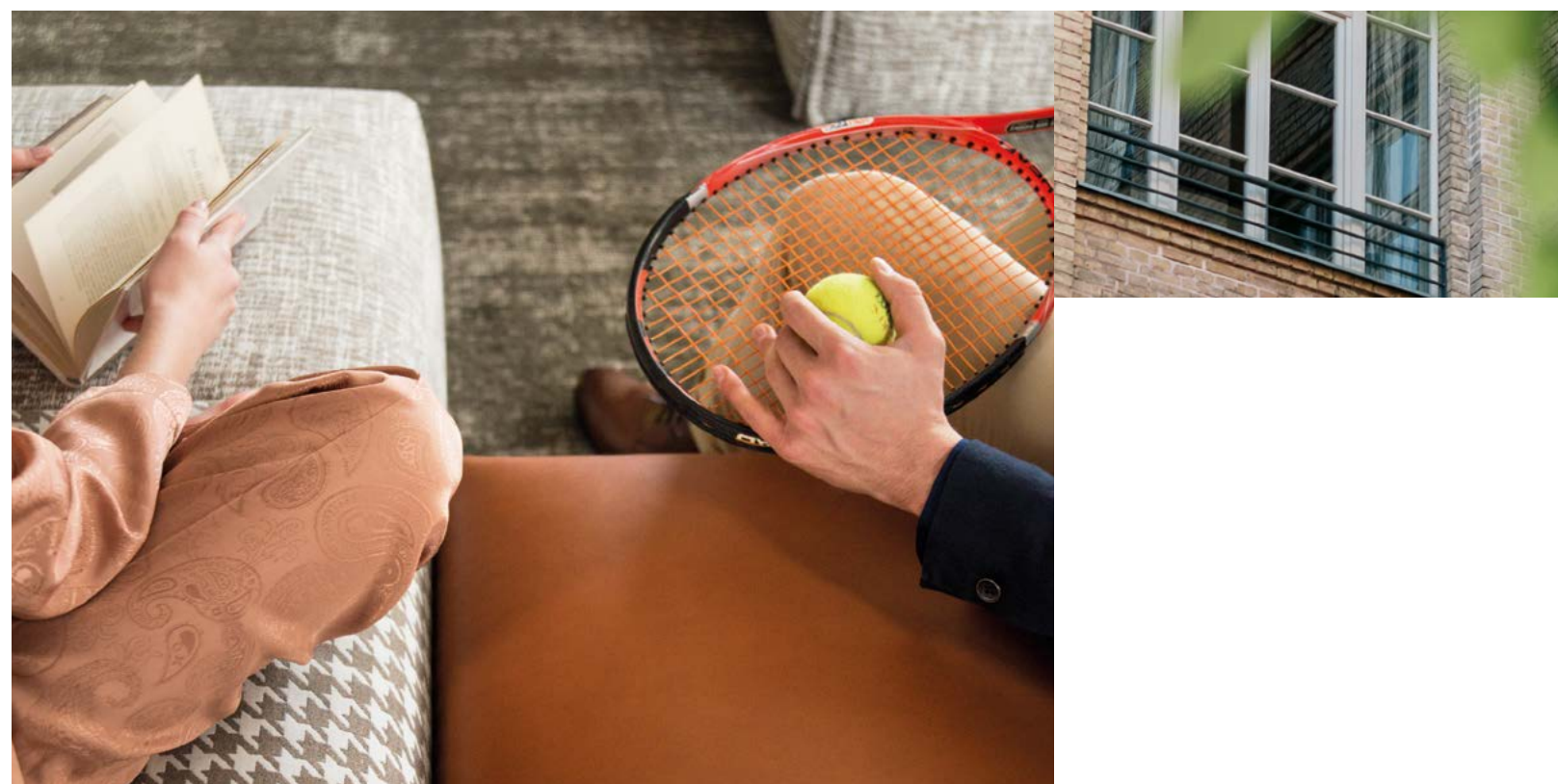



HIP HOP

EXPERIENCE

Best seller della collezione, Hip Hop è una vera e propria icona del brand Calia Italia. La sua particolare forma lo rende unico sia dal punto di vista estetico che ergonomico: la silhouette del divano dà vita a una curva morbida che unisce seduta e poggiatesta, accoglie il corpo e si completa con un soffice cuscino. Un divano che prima invita e poi conquista, con una comfort experience mai provata prima. Grazie alla presenza di moduli trapezoidali Hip Hop può dare vita a composizioni originali e sinuose.

The best seller of the collection, Hip Hop is a true icon of the brand. Its particular shape makes it unique both from an aesthetic and ergonomic point of view. The silhouette of the sofa gives life to a soft curve that combines the seat and the backrest, welcoming the body and it is completed with a soft cushion that supports the shoulders. It is a sofa that first invites you and then conquers you with a never-before-tried comfort experience. Thanks to the presence of trapezoidal modules, Hip Hop can give life to original and sinuous compositions.









HIP HOP PRM828_830

HIP HOP PRM828_830
E95+T71+130+130+400

HIP HOP PRM828_830
A99+E97+T71+130+400

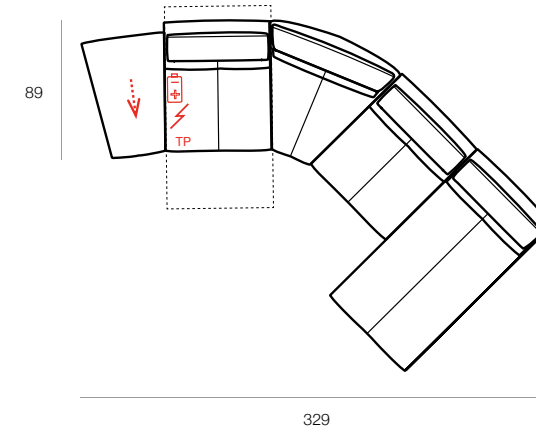

HIP HOP PRM828_830

vers.A99
POUF_X
GALLES 706 AZZURRO
OTTOMAN_X
GALLES 706 AZZURRO

vers.E97
POLTRONA RECLINER ELETTRICO
RICARICABILE SENZA BRACCIOLI
1° RIV: DUBAI V. 3929 AZZURRO
2° RIV: GALLES 706 AZZURRO
ARMLESS RECHARG. ELECTRIC RECLINER CHAIR
1st COV: DUBAI V. 3929 AZZURRO
2nd COV: GALLES_706 AZZURRO

vers.T71
POLTRONA ANGOLO
1° RIV: DUBAI V. 3929 AZZURRO
2° RIV: GALLES 706 AZZURRO
ARMLESS RECHARG. ELECTRIC RECLINER CHAIR
1st COV: DUBAI V. 3929 AZZURRO
2nd COV: GALLES 706 AZZURRO

vers.E95
POLTRONA RECLINER
ELETTRICO
SENZA BRACCIOLI
1° RIV: BABY 305
2° RIV: BABY 600
ARMLESS ELECTRIC
RECLINER CHAIR
1st COV: BABY 305
2nd COV: BABY 600

vers.T71
POLTRONA ANGOLO
1° RIV: BABY 600
2° RIV: BABY 705
CORNER CHAIR
1st COV: BABY 600
2nd COV: BABY 705

vers.130
POLTRONA SENZA BRACCIOLI
1° RIV: BABY 804
2° RIV: BABY 600
ARMLESS CHAIR
1st COV: BABY 804
2nd COV: BABY 600

vers.130
POLTRONA SENZA BRACCIOLI
1° RIV: BABY 804
2° RIV: BABY 500
ARMLESS CHAIR
1st COV: BABY 804
2nd COV: BABY 500

vers.400
CHAISE LONGUE
1° RIV: BABY 707
2° RIV: BABY 705
CHAISE LONGUE
1st COV: BABY 707
2nd COV: BABY 705

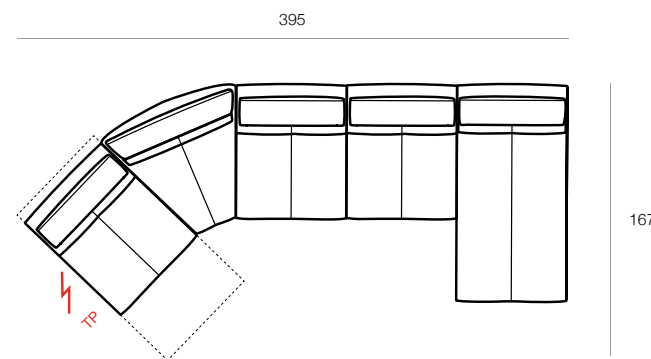

HIP HOP PRM828_830
E95+T71+130+130+400

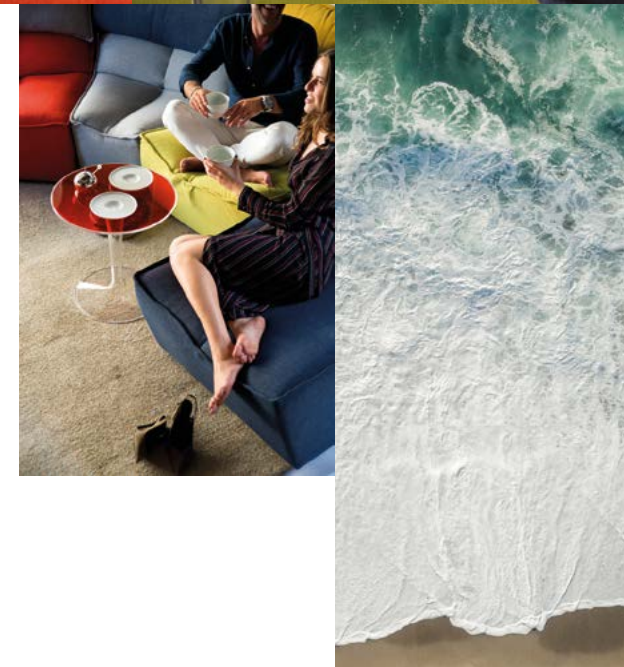

vers.130
POLTRONA SENZA BRACCIOLI
1° RIV: DUBAI V. 3929 AZZURRO
2° RIV: GALLES 706 AZZURRO
ARMLESS CHAIR
1st COV: DUBAI V. 3929 AZZURRO
2nd COV: GALLES 706 AZZURRO

vers.400
CHAISE LONGUE
1° RIV: GALLES 706 AZZURRO
2° RIV: DUBAI V.3929 AZZURRO
CHAISE LONGUE
1st COV: GALLES 706 AZZURRO
2nd COV: DUBAI V. 3929 AZZURRO



HIP HOP PRM828_830
A99+E97+T71+130+400



FOX TROT

EXPERIENCE

Come una trapunta morbida e accogliente, Fox Trot è il divano modulare che avvolge con un design sinuoso e una lavorazione geometrica. Elementi lineari e angolari, chaise longue e pouf permettono di creare la composizione perfetta per i desideri e la comfort experience di chi lo sceglie.

Like a soft and cozy quilt, Fox Trot is a modular sofa that envelops you with a sinuous design and geometric workmanship. Its linear and angular elements, chaise-longue and footstool allow you to create the perfect composition for your desires and comfort experience.

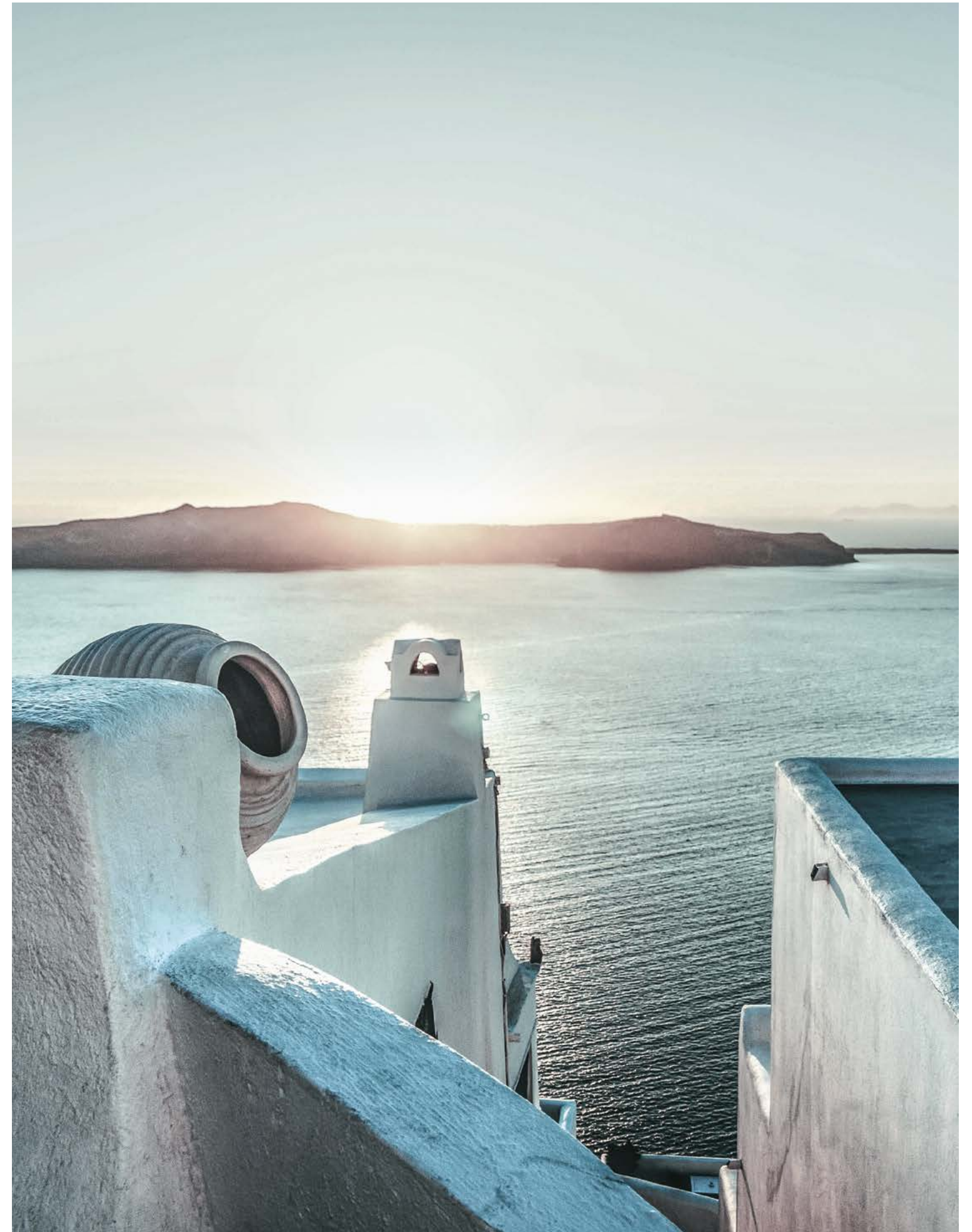







FOX TROT PRM1063
400+130+130+000+130+635

FOX TROT PRM1063

vers.400
CHAISE LONGUE
DANDY 23055 COL.804 SENAPE
CHAISE LONGUE
DANDY 23055 COL.804 SENAPE

vers.130
POLTRONA SENZA BRACCIOLI
BULL 370 BIANCO PURO
ARMLESS CHAIR
BULL 370 BIANCO PURO

vers.130
POLTRONA SENZA BRACCIOLI
DUBAI V.3928 BLU
ARMLESS CHAIR
DUBAI V.3928 BLU

vers.000
ANGOLO
DANDY 23055 COL.804 SENAPE
CORNER
DANDY 23055 COL.804 SENAPE

vers.130
POLTRONA SENZA BRACCIOLI
DANDY 23055 COL.600 VERDE SCURO
ARMLESS CHAIR
DANDY 23055 COL.600 VERDE SCURO

vers.635
POUF RETTANGOLARE
BULL 370 BIANCO PURO
RECTANGULAR OTTOMAN
BULL 370 BIANCO PURO

358

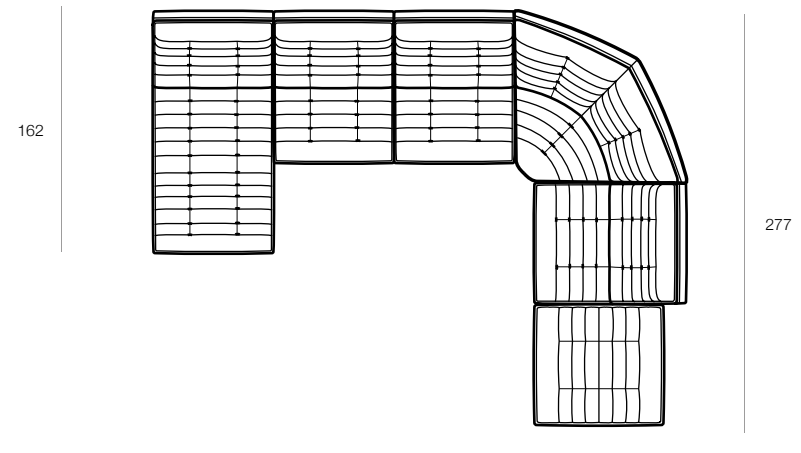

162

277

102

FOX TROT PRM1063
400+130+130+000+130+635



JOHNNY

EXPERIENCE

Componibile, multicolore, dalle soffici imbottiture: Johnny è un divano che una volta provato non si lascia più andar via. Con le sue dimensioni generose, la forma morbida, le spalliere alte e il poggiatesta regolabile manualmente -nelle versioni che lo prevedono- Johnny ha anche una versione recliner, in cui la seduta è completamente reclinabile, e una versione con bracciolo corredato di tasca portaoggetti. Un divano che dà spazio a tutte le passioni e regala una comfort experience da vivere e condividere.

Modular, multicoloured and with soft padding, Johnny is a sofa that once you have tried it, you will never want to let it go. It has a generous size, soft shape, high backrests and manually adjustable headrest (included in selected versions) and is also available in a recliner version, in which the seat is completely reclining. There is even a version with an armrest equipped with a storage pocket. Johnny is a sofa that gives space to all passions and gives a comfort experience to live and share.









JOHNNY PRM1136
781+J82+J84+J82+E95

JOHNNY PRM1136
781+J82+J84+J82+E95

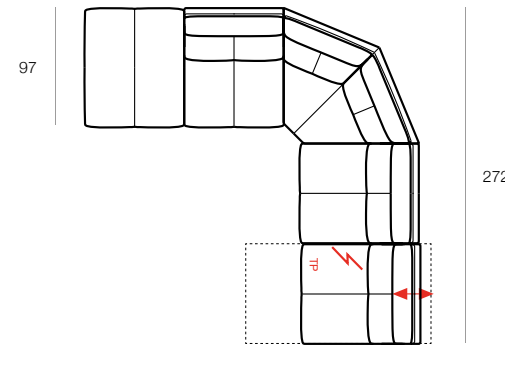

272



JOHNNY PRM1136

vers.781
POUF MERIDIEN
ACAPULCO 500 GIALLO
MERIDIAN OTTOMAN
ACAPULCO 500 GIALLO

vers.J82
POLTRONA SENZA BRACCIALI POGGIATESTA FISSO
1° RIV: ACAPULCO 402 SABBIA
2° RIV: ACAPULCO 402 SABBIA
3° RIV: ACAPULCO 310 ROSA
FIXED HEADREST ARMLESS CHAIR
1st COV: ACAPULCO 402 SABBIA
2nd COV: ACAPULCO 402 SABBIA
3rd COV: ACAPULCO 310 ROSA

vers.J84

ANGOLO POGGIATESTA FISSO
1° RIV: ACAPULCO 301 ARANCIO; 2° RIV: ACAPULCO 301 ARANCIO
3° RIV: ACAPULCO 406 ECRU'
FIXED HEADREST CORNER
1st COV: ACAPULCO 301 ARANCIO; 2nd COV: ACAPULCO 301 ARANCIO
3rd COV: ACAPULCO 406 ECRU'

vers.J82

POLTRONA SENZA BRACCIOI POGGIATESTA FISSO
1° RIV: ACAPULCO 001 VINACCIA; 2° RIV: ACAPULCO 001 VINACCIA
3° RIV: ACAPULCO 500 GIALLO
FIXED HEADREST ARMLESS CHAIR
1st COV: ACAPULCO 001 VINACCIA; 2nd COV: ACAPULCO 001 VINACCIA
3rd COV: ACAPULCO 500 GIALLO

vers.E95

POLTRONA RECLINER ELETTRICO SENZA BRACCIOI
1° RIV: ACAPULCO 705 OTTANIO; 2° RIV: ACAPULCO 705 OTTANIO
3° RIV: ACAPULCO 500 GIALLO
ARMLESS ELECTRIC RECLINER CHAIR
1st COV: ACAPULCO 705 OTTANIO; 2nd COV: ACAPULCO 705 OTTANIO
3rd COV: ACAPULCO 500 GIALLO



INDICE SINOTTICI I TECHNICAL DATA INDEX	
LAZY/LAZY_2.CAL 1107/1107_2	78
MODULA.PRM 1077/1019	78
ELISEO.PRM 1127	79
TANGO.CAL 827/818	80
HIP HOP.PRM 830/828	80
FOX TROT.PRM 1063	81
JOHNNY.PRM 1136	81

LAZY.1107 | LAZY_2.1107_2

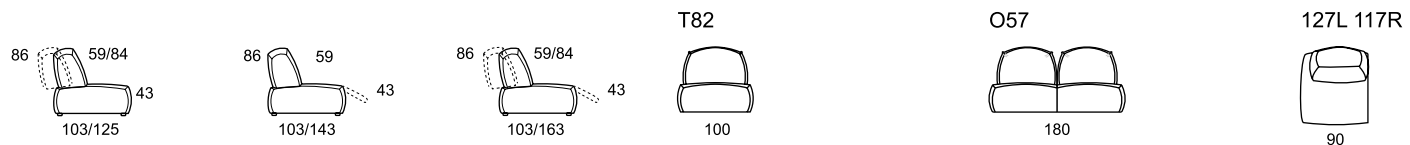

120L 110R

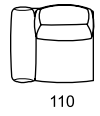

420L 410R

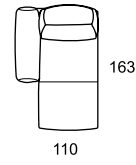

130



O57

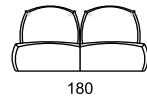

127L 117R



MODULA.1077 | MODULA SFOD.1019

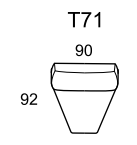
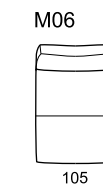
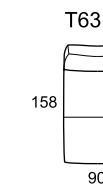
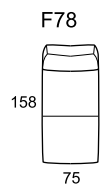
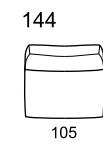

AD7

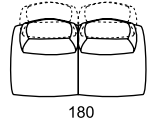

AA8L AA7R



AH1L AH0R



Q69



174L 173R

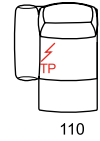

040

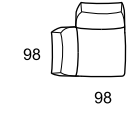

I91L I90R

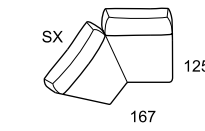

E82

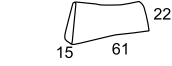

641

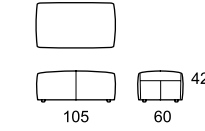

635

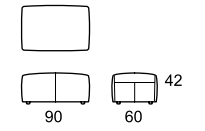

E95

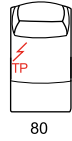

AB1



AH5L AH4R

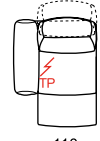

558L 557R

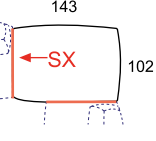

879

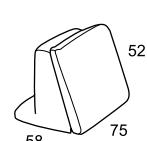

I94

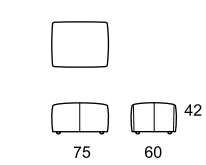

A35L A24R

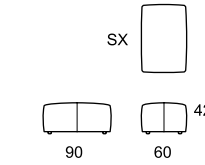

I98

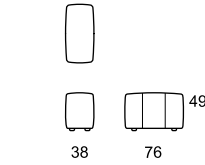

I96

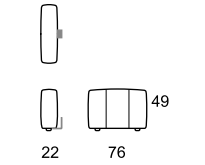

M00

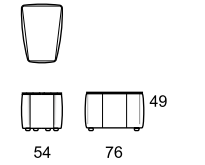

540

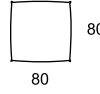

A35L A24R

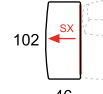

N91

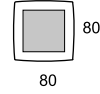

658



E81

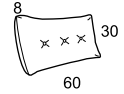

M04

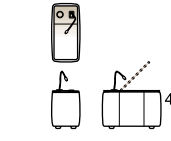

M02

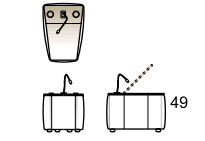

B32

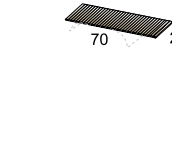

O53

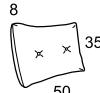

H89

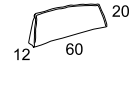

ELISEO.1127

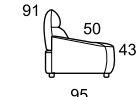
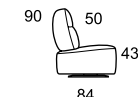

300

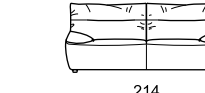

120L 110R



130

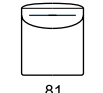

A32



147L 146R

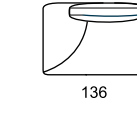

420L 410R

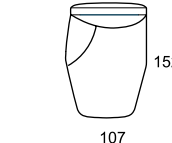

000

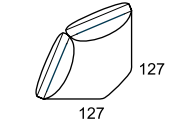

040

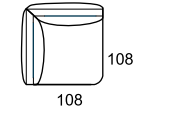

MODULA.1077 | MODULA SFOD.1019

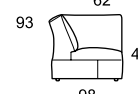
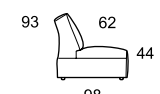

120L 110R



D62



130



O20



072L 071R

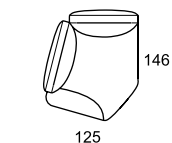

560

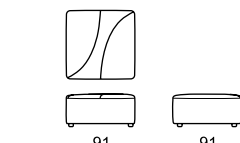

635

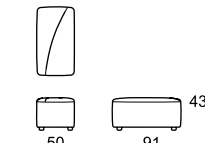

TANGO.827 | TANGO_SFOD.818

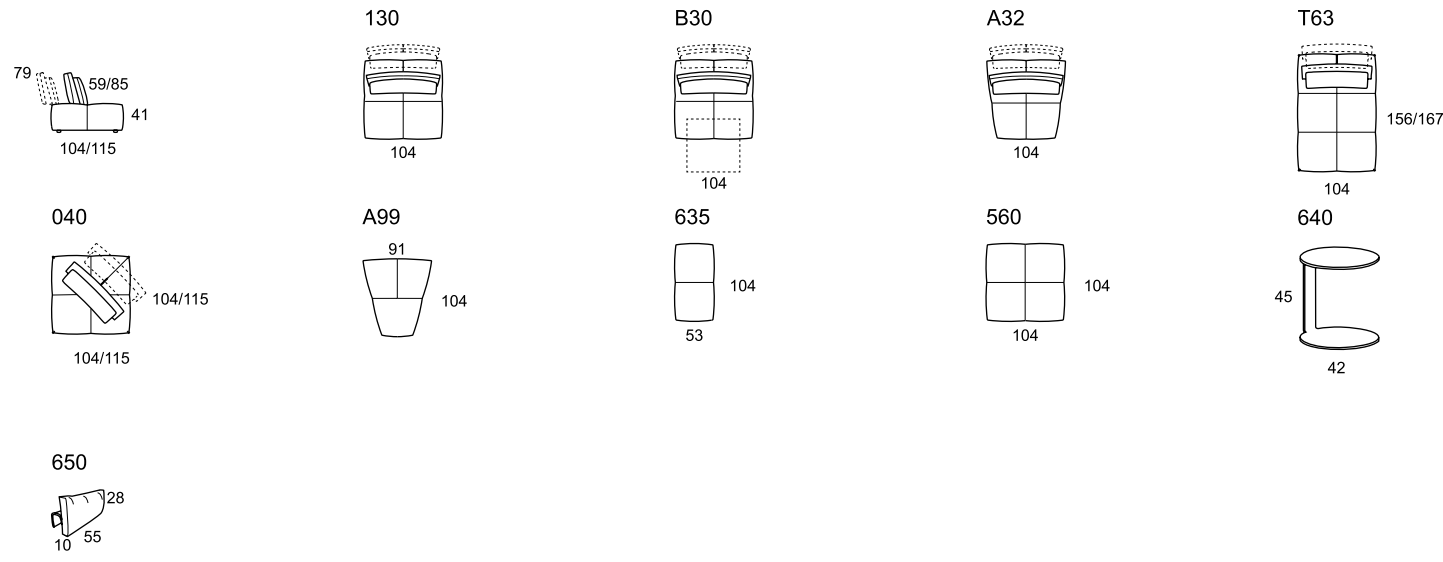

FOX TROT.1063

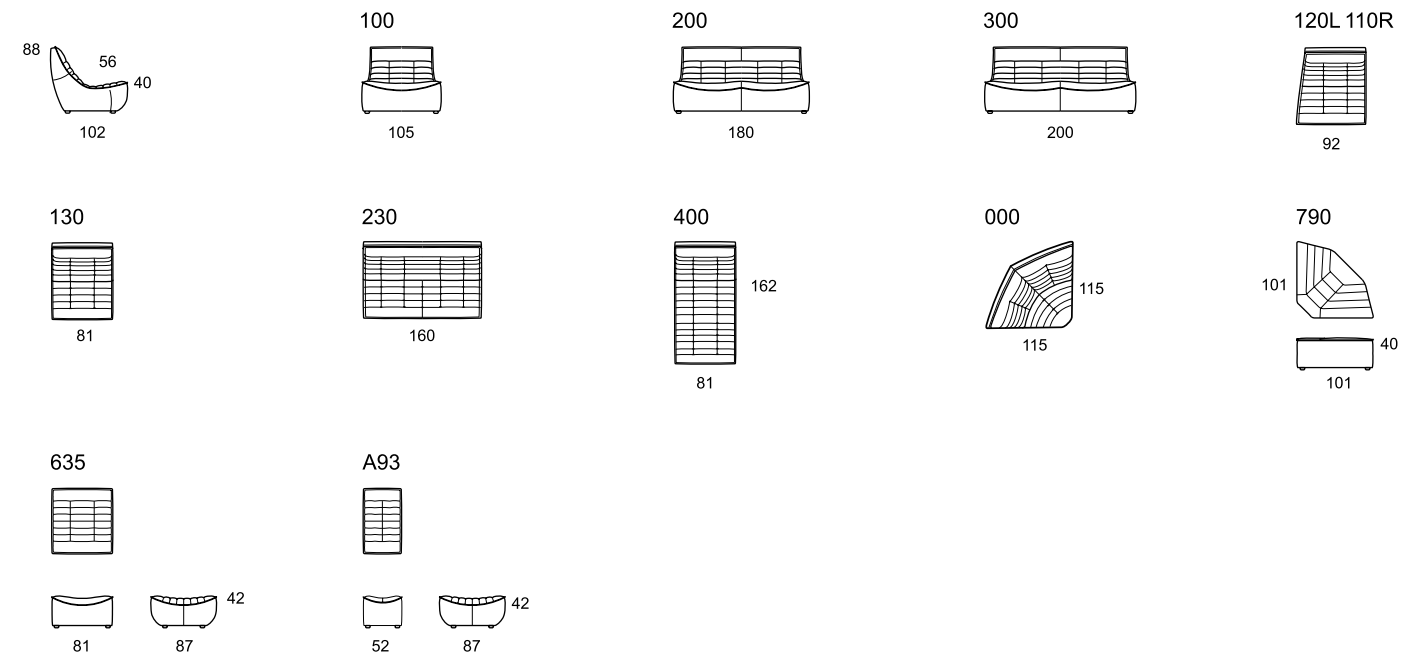

HIP HOP.830 | HIP HOP_SFOD.828

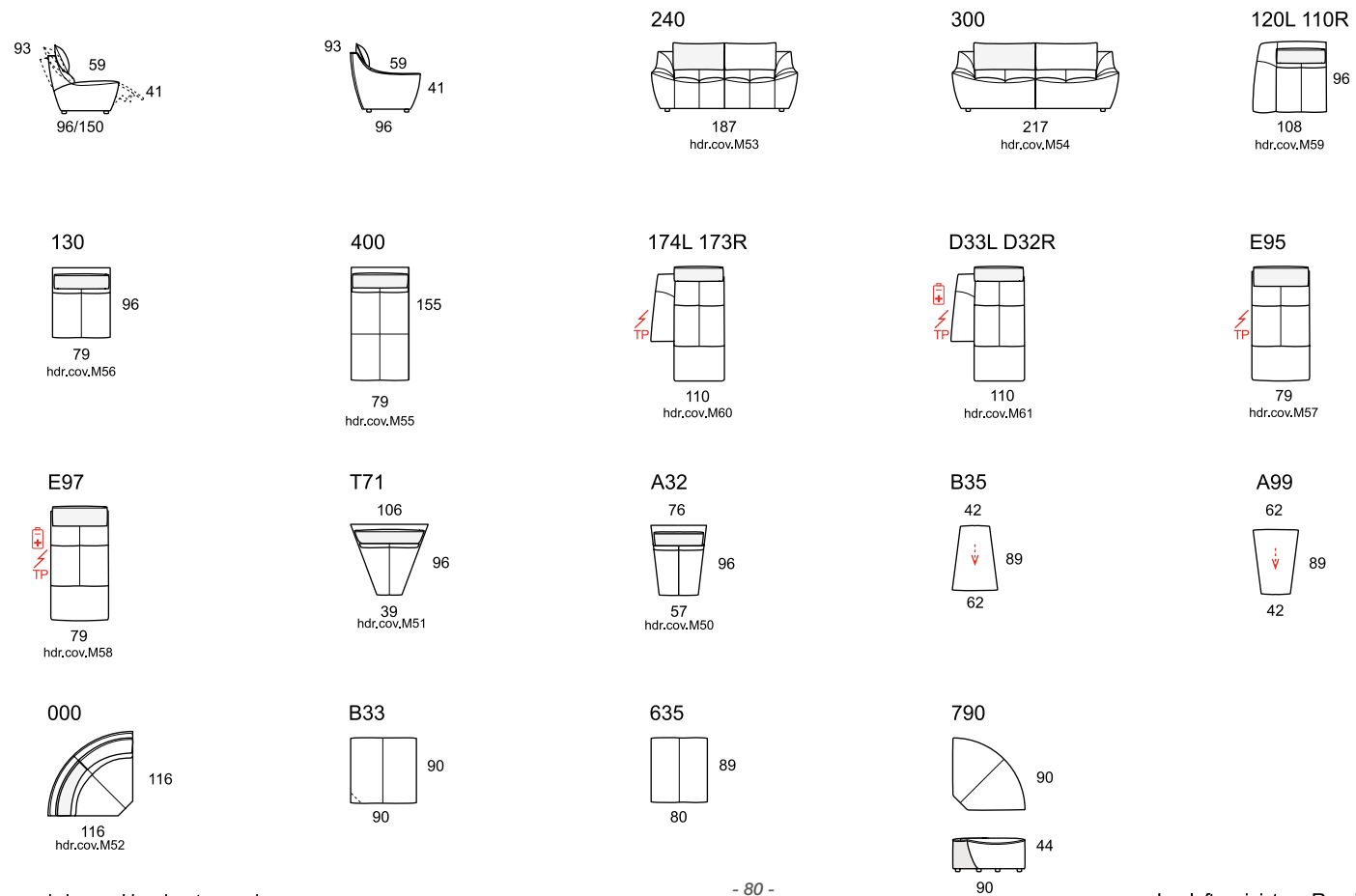

hdr.cov. Headrest covering

L = left = sinistro R = right = destro

JONNY.1136

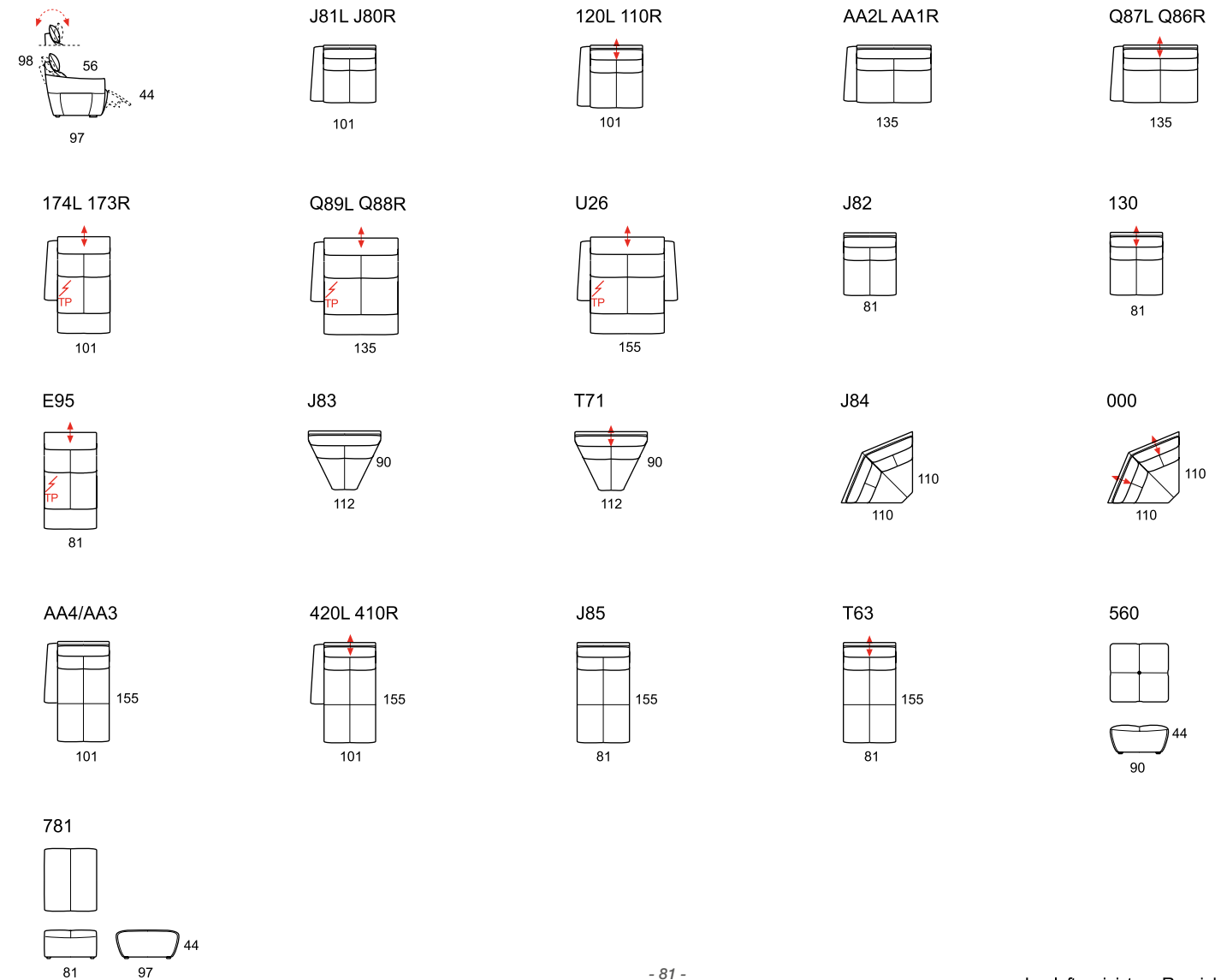

L = left = sinistro R = right = destro



Concept and artwork | BBSADV
Art Director | Carmine Pianelli
Photo | Sara D'Angelo
Still life | ATIPIX

Stampato nel Marzo 2020
Printed in March 2020

Calia Italia si riserva di apportare, senza preavviso, modifiche nei materiali, nei rivestimenti, nelle finiture e nei disegni dei prodotti di questo catalogo. I colori e le texture dei materiali e delle finiture hanno valore indicativo in quanto soggetti alle tolleranze dei processi di stampa.

Calia italia reserves the right to change, amend and modify, without previous notice, all or any materials, covers, finishes, drawings and specifications of the products featured in this catalog. Textures and colors of materials and finishes are indicative as they are the outcome of the printing process.

Calia Trade S.p.A.
Sede Legale
Viale Gregorio VII, 386
00165 Roma, Italy

Sede Operativa
Contrada Serretiello la Valle
75100 Matera, Italy
info@caliatrade.com
Tel. +39 0835 303910



MATERA 2019
OPEN FUTURE

CALIA ITALIA
OFFICIAL COMFORT SUPPLIER

MATERA 2019
EUROPEAN CAPITAL OF CULTURE

Le nostre certificazioni | Our certifications



AZIENDA CON SISTEMA
DI GESTIONE AMBIENTALE
CERTIFICATO DA DNV GL
■ ISO 14001 ■



AZIENDA CON SISTEMA
DI GESTIONE QUALITÀ
CERTIFICATO DA DNV GL
■ ISO 9001 ■

